

**JOKA®**



**555 XXL**

Designvloeren  
Sols design  
Designböden  
Design flooring

## 555 XXL

2,5 mm Lijmvarianten

Variante encollée / Klebevariante / Adhesive version

9631	Chateau Oak Beige EIR	6	Voordeelen	5
9632	Chateau Oak Grey EIR	8	Avantages / Vorteile / Advantages	
9633	Chateau Oak Natural EIR	10	Productdetails	16
9634	Chateau Oak Classic EIR	12	Détails du produit / Produktdetails /	
9635	Chateau Oak Dark EIR	14	Product details	
			Garantieverklaring	17
			Avis de garantie / Gewährleistungs- hinweis / Warranty note	
			Accentstrepen	18
			Filets / Akzentstreifen / Feature strips	



Technische gegevens, certificaten, leg- en onderhoudsinstructies vindt u hier:

Vous trouverez les instructions de pose, les certificats et les conseils d'entretien sur notre site: /  
Technische Daten, Zertifikate, Verlege- und Pflegeanleitungen finden Sie hier: / For fitting instruc-  
tions, certificates and maintenance instructions, see:





**Royaal ruim-  
telijk effect**



Effet d'espace généreux  
Großzügige Raumwirkung  
Generous spatial effect



Surface super mate  
Supermatte Oberfläche  
Super matt surface

**Supermat  
oppervlak**



Pore synchrone  
Synchronpore  
Embossed in register

**Synchron  
Pore EIR**





# Ontwerp toont grootsheid

Le design montre la grandeur / Design zeigt Größe / Design shows greatness



## Authentieke, synchroon geperste oppervlaktestructuur

Texture de surface authentique, façonnée de manière synchrone / Authentische, synchronegeprägte Oberflächenstruktur / Authentic surface texture with synchronous embossing

## Hoge vochtbescherming

Haute protection contre l'humidité / Hoher Feuchtigkeitsschutz / High moisture protection

## Onderhoudsvriendelijk oppervlak

Facilité d'entretien / Pflegeleichte Oberfläche / Easy care surface

## Aangenaam loop- en stacomfort

Agréable sous les pieds / Angeneher Geh- und Stehkomfort / Pleasant walking and standing comfort

## Extra grote planken

Des planches ultra-grandes / Extra große Planken / Extra large planks

## Duurzaam en robuust

Durable et robuste / Langlebig und robust / Durable and sturdy

# 555 XXL

## 963I Chateau Oak Beige EIR

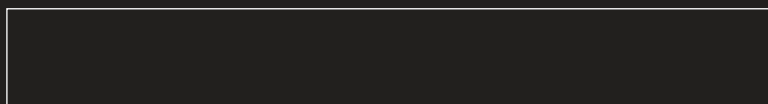

**963I** 22,86 x 180,00 cm

Dikte Calibre / Stärke / Thickness 2,5 mm

Pakket Paquet / Paket / Package = 4,11 m<sup>2</sup>

Palett Palette / Palette / Pallett = 263,04 m<sup>2</sup>



Garantie Garantie /  
Garantie / Guarantee



Afgeschuinde randen  
Lames chanfreinées  
/ Gefaste Kanten /  
Bevelled edges



Synchron pore EIR  
Embossed in register  
/ Pore synchrone /  
Sincroporo



**De eigen ruimte fotograferen en de vloer virtueel vervangen!**

Scanner le code et utiliser le revêtement de sol design dans le planificateur d'espace!

Eigenen Raum fotografieren und Boden virtuell wechseln!

Scan the code and use the design flooring in the room planner!



# 555 XXL

## 9632 Chateau Oak Grey EIR

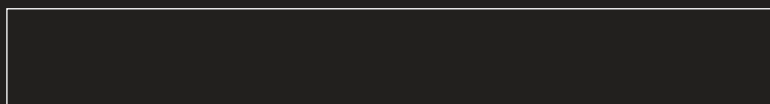

**9632** 22,86 x 180,00 cm

Dikte Calibre / Stärke / Thickness 2,5 mm

Pakket Paquet / Paket / Package = 4,11 m<sup>2</sup>

Palett Palette / Palette / Pallett = 263,04 m<sup>2</sup>



Garantie Garantie /  
Garantie / Guarantee



Afgeschuinde randen  
Lames chanfreinées  
/ Gefaste Kanten /  
Bevelled edges



Synchron pore EIR  
Embossed in register  
/ Pore synchrone /  
Sincroporo



**De eigen ruimte fotograferen en de vloer virtueel vervangen!**

Scanner le code et utiliser le revêtement de sol design dans le planificateur d'espace!

Eigenen Raum fotografieren und Boden virtuell wechseln!

Scan the code and use the design flooring in the room planner!





# 555 XXL

## 9633 Chateau Oak Natural EIR

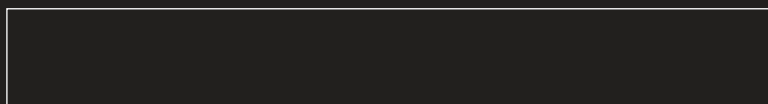

**9633** 22,86 x 180,00 cm

Dikte Calibre / Stärke / Thickness 2,5 mm

Pakket Paquet / Paket / Package = 4,11 m<sup>2</sup>

Palett Palette / Palette / Pallett = 263,04 m<sup>2</sup>



Garantie Garantie /  
Garantie / Guarantee



Afgeschuinde randen  
Lames chanfreinées  
/ Gefaste Kanten /  
Bevelled edges



Synchron pore EIR  
Embossed in register  
/ Pore synchrone /  
Sincroporo



**De eigen ruimte fotograferen en de vloer virtueel vervangen!**

Scanner le code et utiliser le revêtement de sol design dans le planificateur d'espace!

Eigenen Raum fotografieren und Boden virtuell wechseln!

Scan the code and use the design flooring in the room planner!



# 555 XXL

## 9634 Chateau Oak Classic EIR

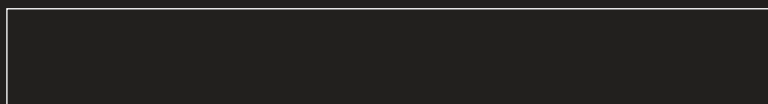

**9634** 22,86 x 180,00 cm

Dikte Calibre / Stärke / Thickness 2,5 mm

Pakket Paquet / Paket / Package = 4,11 m<sup>2</sup>

Palett Palette / Palette / Pallett = 263,04 m<sup>2</sup>



Garantie Garantie /  
Garantie / Guarantee



Afgeschuinde randen  
Lames chanfreinées  
/ Gefaste Kanten /  
Bevelled edges



Synchron pore EIR  
Embossed in register  
/ Pore synchrone /  
Sincroporo



**De eigen ruimte fotograferen en de vloer virtueel vervangen!**

Scanner le code et utiliser le revêtement de sol design dans le planificateur d'espace!

Eigenen Raum fotografieren und Boden virtuell wechseln!

Scan the code and use the design flooring in the room planner!





# 555 XXL

## 9635 Chateau Oak Dark EIR

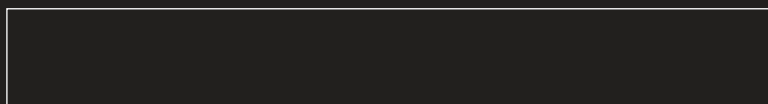

**9635** 22,86 x 180,00 cm

Dikte Calibre / Stärke / Thickness 2,5 mm

Pakket Paquet / Paket / Package = 4,11 m<sup>2</sup>

Palett Palette / Palette / Pallett = 263,04 m<sup>2</sup>



Garantie Garantie /  
Garantie / Guarantee



Afgeschuinde randen  
Lames chanfreinées  
/ Gefaste Kanten /  
Bevelled edges



Synchron pore EIR  
Embossed in register  
/ Pore synchrone /  
Sincroporo



**De eigen ruimte fotograferen en de vloer virtueel vervangen!**

Scanner le code et utiliser le revêtement de sol design dans le planificateur d'espace!

Eigenen Raum fotografieren und Boden virtuell wechseln!

Scan the code and use the design flooring in the room planner!



Designvloeren Sols design / Designböden / Design flooring 555 XXL | 9635 Chateau Oak Dark EIR



## 555 XXL

2,5 mm Lijmvarianten  
2,5 mm Variante encollée  
2,5 mm Klebevariante  
2,5 mm Adhesive version

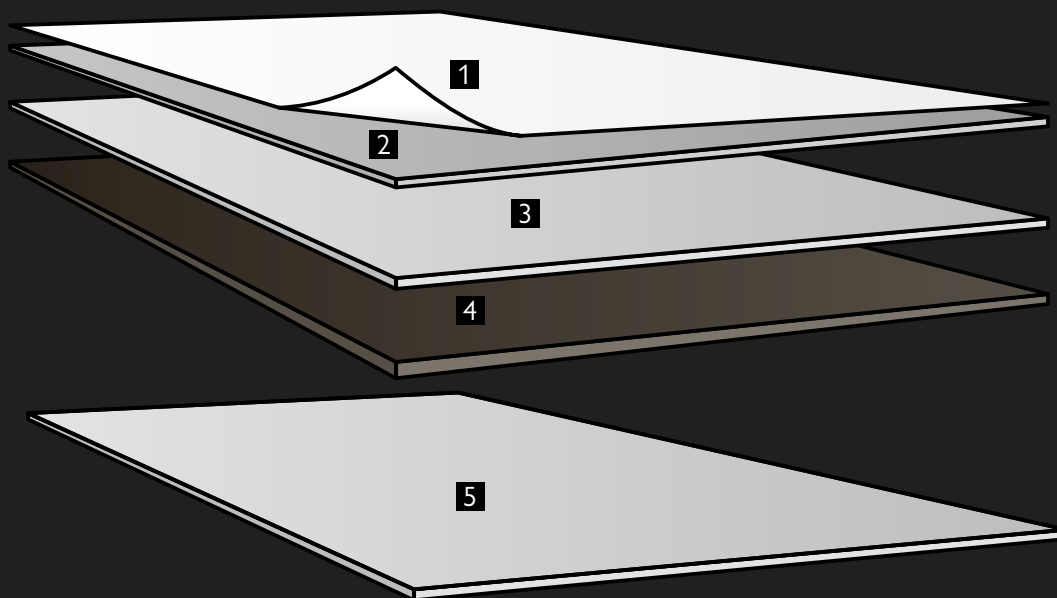

**1** Transparant 0,55 mm slijtlaag  
incl. PU-coating

Couche d'usure transparente traitement  
PU incl. / Transparente 0,55 mm Nutz-  
schicht inkl. PU-Vergütung / Transparent  
wear layer incl. PU treatment

**2** Fotofilm (hout/steen)  
Film décoratif (bois/pierre) /  
Fotofilm (Holz/Stein) /  
Printed film layer (wood/stone)

**3** Stabilisatielaag  
Couche de stabilisation /  
Stabilisierungsschicht /  
Stabilisation layer

**4** Dragermateriaal  
PVC

Couche de fond PVC /  
Trägermaterial PVC /  
Support layer PVC

**5** Aanbevolen onderlaag:  
**JK 160 Silent Allrounder**  
Sous-couche recommandée /  
Empfohlende Unterlage /  
Recommended underlay



## Synchrone poriën EIR / Pore synchrone / Synchronpore / Embossed in register



### **Authentieke, synchroon geperste oppervlaktestructuur**

Texture de surface authentique, façonnée de manière synchrone / Authentische, synchroneprägte Oberflächenstruktur / Authentic surface texture with synchronous embossing

## Garantieverklaring / Avis de garantie / Gewährleistungshinweis / Warranty note

---

Voorbeelden, folders en foto's dienen slechts ter oriëntatie en zijn niet-bindend. De leeftijd en de blootstelling aan zonlicht zijn van invloed op de natuurlijke kleurverandering van gedrukte patronen. Het is mogelijk dat de kleuren in gedrukte media of afbeeldingen op het beeldscherm afwijken van de originele kleuren. Daardoor kan het product op het moment van levering aanzienlijk afwijken van het monster-exemplaar. Doorslaggevend voor de concrete producteigenschappen is uitsluitend de actuele technische documentatie die u vindt op [www.jordanshop.nl](http://www.jordanshop.nl).

Les échantillons, les brochures et les photos ont uniquement une valeur indicative et sont sans engagement. Le vieillissement et l'exposition au soleil ont une influence sur le changement naturel de couleur des décors imprimés. Des variations de couleur entre les documents imprimés ou les représentations sur écran et l'original sont possibles. C'est pourquoi au moment de la livraison, le produit peut nettement différer de l'échantillon. Seule la fiche technique actuelle que vous trouverez sur [www.jordanshop.nl](http://www.jordanshop.nl) détermine les caractéristiques concrètes du produit.

Muster, Prospekte und Fotos dienen nur der groben Orientierung und sind unverbindlich. Das Alter und die Einwirkung von Sonnenlicht hat Einfluss auf die natürliche Farbveränderung gedruckter Dekore. Farbabweichungen in Druckmedien oder Bildschirmdarstellungen zum Original sind möglich. Dadurch kann das Produkt zum Zeitpunkt der Auslieferung deutliche Unterschiede zur Mustervorlage aufweisen. Maßgeblich für die konkreten Produkteigenschaften ist ausschließlich das aktuelle Technische Datenblatt, das Sie unter [www.jordanshop.nl](http://www.jordanshop.nl) finden.

All samples, brochures and photos are therefore only provided in order to give you rough idea and are not binding. Both age and exposure to sunlight do impact on the natural printed finish colour changes. The colours of the original may therefore vary from the way they look in print media or on a screen. At the time of delivery, the product may therefore differ clearly from the material sample provided. Only the technical data sheet, which you can find at [www.jordanshop.nl](http://www.jordanshop.nl), is relevant with regard to specific product properties.

# Accentstrepen / Filets / Akzentstreifen / Feature strips

Het gebruik van designelementen ondersteunt de sfeer doorslaggevend. Accentstrepen zijn in verschillende kleuren verkrijgbaar.

L'utilisation d'éléments design conforte l'ambiance de façon déterminante. Les baguettes décoratives sont disponibles en différentes couleurs.

Dikte Calibre / Stärke / Thickness 2,3 mm

Der Einsatz von Designelementen unterstützt das Ambiente entscheidend. Akzentstreifen sind in unterschiedlichen Farben erhältlich

The use of design elements has a major impact on the ambiance. Accent strips are available in different colours.



**White** 3 x 915 mm

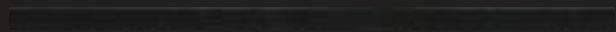

**Black** 3 x 915 mm



**Light Beige** 3 x 915 mm



**Dark Grey** 3 x 915 mm



**Brown** 3 x 915 mm

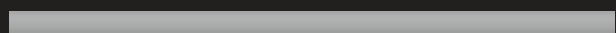

**Silver** 3 x 915 mm



**White** 6 x 915 mm

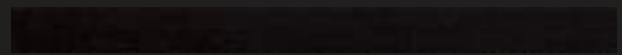

**Black** 6 x 915 mm



**Light Beige** 6 x 915 mm

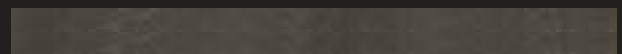

**Dark Grey** 6 x 915 mm

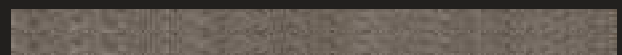

**Brown** 6 x 915 mm

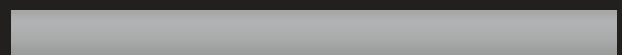

**Silver** 6 x 915 mm

Plinten wit / Plinthes blanches / Sockelleisten weiß / Skirting boards white



FO 631



FO 842

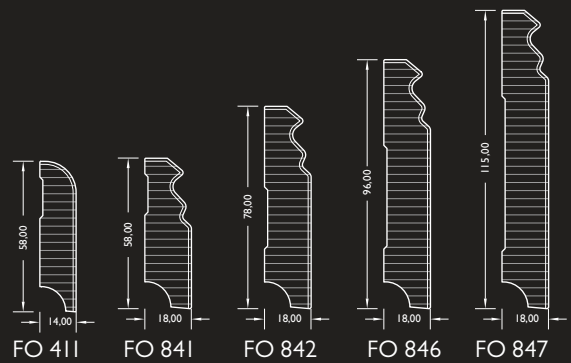
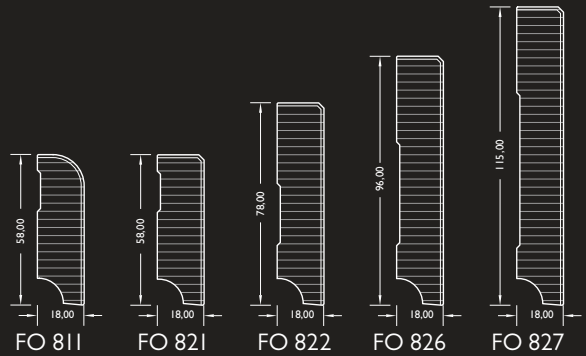
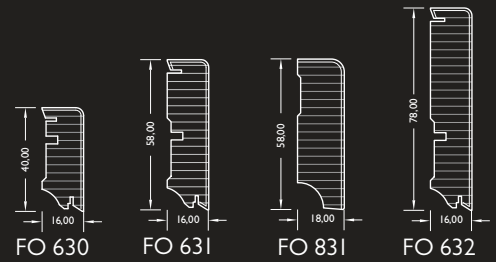

Bijpassende plinten / Plinthes assorties / Abgestimmte Sockelleisten / Matching skirting boards



FO 660

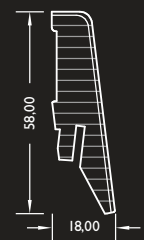

Clip 660





Alle JOKA / INKU designvloeren voldoen aan alle fundamentele Europese veiligheids- & gezondheidsrichtlijnen.

La gamme des revêtements de sol JOKA/ INKU Sols Design répond à toutes les exigences européennes en matière de santé et de sécurité .

Alle JOKA/INKU Designböden entsprechen allen grundlegenden europäischen Sicherheits- & Gesundheitsrichtlinien

All JOKA/INKU Design floors meet all essential European Health and Safety Directives.



Het Indoor Air Comfort Gold certificaat garandeert de emissies bij een product. Het combineert alle Europese verordeningen inzake VOC evenals alle relevante vrijwillige ecolabels.

Le certificat Indoor Air Comfort Gold garantit les émissions les plus faibles possibles pour ce produit. Il englobe toutes les réglementations européennes sur les COV (composés organiques volatils) ainsi que les ecolabels appropriés (sur une base volontaire).

Das Indoor Air Comfort Gold Zertifikat garantiert niedrigste Emissionen bei einem Produkt. Es kombiniert alle europäischen Verordnungen zu VOC sowie alle relevanten freiwilligen Umweltzeichen.

The Indoor Air Comfort Gold Certificate guarantees lowest emissions for a product. It combines all European regulations on VOC as well as all relevant voluntary environmental labels.



Designvloeren zijn ftalaatvrij! Het bewustzijn voor de maatschappelijke, sociale en ecologische verantwoordelijkheid van alle ondernemingsactiviteiten is een van onze bedrijfsprincipes. Daarom heeft JOKA / INKU bewust gekozen voor alternatieve, ftalaatvrije weekmakers voor zijn designvloeren.

Les Sols Design sont sans phtalate !! La prise de conscience de la responsabilité sociétale, sociale et environnementale dans toutes nos activités est l'un des fondements de notre société. Pour cette raison, JOKA/INKU a décidé en connaissance de cause de passer à des plastifiants de substitution sans phtalate pour ses Sols Design .

Designböden sind phthalatfrei! Das Bewusstsein für die gesellschaftliche, soziale und ökologische Verantwortung aller Unternehmensaktivitäten ist einer unserer Unternehmensgrundsätze. Aus diesem Grund entschied sich JOKA/INKU bewusst, bei seinen Designböden, auf alternative, phthalatfreie Weichmacher umzusteigen.

Design floors are phthalate-free! An awareness of the societal, social and environmental responsibility of all corporate activities is one of our corporate principles. This is the reason why JOKA/INKU has deliberately decided to switch to alternative, phthalate-free plasticisers in its design floors.



In Frankrijk geldende informatie over diffusie van vluchtige stoffen (A+ zeer zwakke emissie tot C zeer sterke emissie).



In Pour la France des informations valides sont nécessaires sur la diffusion de substances volatiles allant de A+ très faible émission à -C très forte émission .

In Frankreich gültige Information über die Diffusion von flüchtigen Stoffen (A+ sehr schwache Emission bis C sehr starke Emission).

Information valid in France on the diffusion of volatiles (A+ very weak emission up to C very strong emission).



Het Floorscore®-certificaat bevestigt, dat alle JOKA / INKU designvloeren de kwaliteit van de lucht in de ruimte niet beïnvloeden.

Le certificat Floorscore® confirme que tous les revêtements de sol JOKA/INKU Design offrent une bonne qualité d'air intérieur.

Das Floorscore®-Zertifikat bestätigt, dass alle JOKA/INKU Designböden die Raumluftqualität nicht beeinträchtigen.

The Floorscore® certificate confirms that all JOKA/INKU design floors have good indoor air quality.

## REACH

De REACH-verordening (Registration, Evaluation, Authorisation and Restriction of Chemicals) verplicht fabrikanten/importeurs te informeren over Stoffen van de „Kandidatenlijst van het Europees Agentschap voor chemische stoffen“ waarvan het aandeel een concentratie van 0,1 massaprocent overstijgt.

lémentation REACH (Enregistrement, Evaluation, Autorisation and Restriction des produits chimiques) oblige les fabricants/importateurs à l'information pour ce qui concerne les substances figurant sur la liste de l'Agence européenne des Produits Chimiques dont une partie excède une concentration de 0,1 de sa masse.

Die REACH-Verordnung (Registration, Evaluation, Authorisation and Restriction of Chemicals) verpflichtet Hersteller/Importeure über Substanzen der „Kandidatenliste der Europäischen Chemikalienagentur“ zu informieren, deren Anteil eine Konzentration von 0,1 Massenprozent übersteigt.

The REACH regulation (Registration, Evaluation, Authorisation and Restriction of Chemicals) requires manufacturers/importers to provide recipients with information on substances on the „Candidate list of the European Chemicals agency“, the portion of which exceeds a concentration of 0.1 weight by weight.



Kwaliteit zonder compromissen – en dat gegarandeerd tot 15 jaar in de residentiële en 5 jaar in de commerciële sector. Garantie volgens de garantievoorwaarden.

Qualité irréprochable – et garantie 15 ans dans les lieux de vie et 5 ans dans commercial moyennement. Voir les conditions de garantie.

Qualität ohne Kompromisse – und das garantiert bis zu 15 Jahren im Wohnbereich und 5 Jahren im Objektbereich. Garantie gemäß den Garantiebedingungen.

Quality with no compromise – and guaranteed up to 15 years in your living areas and 5 years in contract areas. Guarantee as per the terms of warranty.



**Gebruiksklassen 23:**

Zwaar woongebruik

Les lieux de vie très sollicité / Wohnbereich mit starker Nutzung / Living areas exposed to heavy use



**Gebruiksklassen 33:**

Projectstoffer met intensief gebruik

Espace commercial très sollicité / Objektbereich mit starker Nutzung / Contract areas exposed heavy use



**Gebruiksklassen 42:**

Industrieel gebruik met normaal gebruik

Domaine industriel normalement / Industrieller Bereich mit normaler Nutzung / Industrial areas exposed to normal use



**Geschikt voor warmwater-vloerverwarming**

Convient tout à fait au chauffage hydraulique par le sol / Geeignet für Warmwasserfußbodenheizung / Suitable for hot water underfloor heating



**Antistatische eigenschappen**

Antistatique / Antistatische Eigenschaften / Antistatic qualities



**Brandklasse Bfl-s1: moeilijk brandbaar**

Classification Bfl-s1: difficilement inflammable  
Brandklasse Bfl-s1: schwer entflammbar  
Fire class Bfl-s1: flame-retardant



**Antislip**

Effet antidérapant / Rutschhemmung / Anti-slip properties



**De eigen ruimte fotograferen en de vloer virtueel vervangen!**

Scanner le code et utiliser le revêtement de sol design dans le planificateur d'espace!

Eigenen Raum fotografieren und Boden virtuell wechseln!

Scan the code and use the design flooring in the room planner!







Onlineshop  
Onlineshop /  
Boutique en ligne /  
Negozio online



Website  
Website /  
Site web /  
Sito web

**JOKA<sup>®</sup>**